



# Sealing Solutions for the Oil and Gas Industries



## About GMORS

From its start in 1986, GMORS has grown to become a recognized multi-national leader in the production of O-Rings and a wide variety of elastomeric sealing devices and products. Our company has more than 1850 employees operating in three ISO certified factories located in Taiwan, China and Thailand.

GMORS' chemists work with many different polymers to formulate high performance elastomeric compounds. All of the elastomeric materials used in our products are compounded and produced in-house.

GMORS is committed to supplying its customers with the highest quality products manufactured efficiently as possible. Our products can be found in numerous critical applications in the aerospace, automotive, CPI, industrial, Oil & Gas, pharmaceutical and semiconductor industries. We are dedicated to meeting each of our customer's current and future needs with exceptional product solutions and service.



# Sealing Solutions for the Oil and Gas Industries

The equipment used throughout the oil and gas industries is subjected to extremely harsh operational and environmental conditions. These adverse conditions often create challenges for the sealing devices used in the equipment that extracts and transports petroleum and gas throughout the world.

At the heart of any elastomeric sealing device is the material from which it is constructed. GMORS' chemists have targeted specific oil and gas industry applications to formulate and develop high performance elastomeric compounds. Our sealing products can tolerate the hostile media, high temperatures and other adverse conditions encountered in oil and gas production operations while maintaining their essential physical properties.

All of our sealing products are subjected to the highest quality standards and can be counted on to deliver superior performance.

## Rapid Gas Decompression

Rapid Gas Decompression (RGD) is a phenomenon that can occur with a rubber sealing device when large pressure gradients exist between its interior and exterior sections. A typical example is when an elastomeric seal, such as an O-Ring, is exposed to a high pressure gas. The gas is ultimately absorbed by the elastomer causing the elastomer to swell. This type of swelling is not necessarily destructive to the O-Ring, however if the system pressure on the O-Ring is rapidly reduced, the gas that had been absorbed will rapidly expand within the O-Ring causing it to rupture and fail catastrophically. (This phenomena is termed Explosive Decompression or ED) Seal failures, such as these, are seen in downhole applications, gas compressors, and potentially in any application exposed to high pressures.

GMORS has developed several unique rapid gas decompression (RGD) resistant elastomeric compounds for use in Oil & Gas applications. They are designed to withstand aggressive chemicals and gases over a wide temperature range while maintaining their sealing properties.



# Elastomeric Compounds for the Oil & Gas Industries

## RGD material features

The RGD resistant compounds listed in the table below have all been independently tested and certified by Element Hutchins. The specific NORSOK M-710 / ISO 23936, NACE TM0297, API6A and TOTAL GS EP PVV 142, standards that each compound meets are identified within the table. GMORS will furnish actual test data upon request.

Compound Number		V9117AA	V9118AA	V9123AA	V9181AA	V9194AA	V9526AA
Polymer		FKM	FKM	FKM	FKM	FKM	FKM
Hardness (Shore A)		90	90	90	90	90	95
Test Condition	NORSOK M710 (ISO 23936)	●	●	●	●	●	●
	NACE TM0297	●					
	TOTAL EP PVV 142	●		●			
	API 6A H <sub>2</sub> S Sour Fluid resistant	●	●	●	●	●	
Compound Features		Recommended for low temperature environments	Excellent chemical compatibility in a wide range of industrial applications	Low and stable compression set at high temperatures	Recommended for very low temperature environments	Recommended for very low temperature environments	Excellent extrusion resistance
Dynamic Service Temperature		-30°C ~220°C	-5°C ~220°C	-15°C ~220°C	-40°C ~220°C	-45°C ~220°C	-15°C ~220°C
Static Service Temperature		-40°C ~250°C	-20°C ~250°C	-25°C ~250°C	-45°C ~250°C	-50°C ~250°C	-25°C ~250°C
Synthetic and Mineral Lubricants Resistance		Excellent	Excellent	Excellent	Excellent	Excellent	Excellent
Aliphatic Hydrocarbons		Excellent	Excellent	Excellent	Excellent	Excellent	Excellent
Aromatic Hydrocarbons		Excellent	Excellent	Excellent	Excellent	Excellent	Excellent
Chemical Resistance		Good	Good	Good	Good	Good	Good



V9617AA	V9623AA	H9100AA	H9120AA	V7617AA	V7618AA	9021A	9091A
FKM	FKM	HNBR	HNBR	FKM	FKM	FFKM	FFKM
95	95	90	90	75	75	90	90
●	●	●	●			●	●
						●	
		●					
●	●	●	●	●	●	●	●
Recommended for low temperature or high pressure environments	Recommended for low compression set or high pressure environments	Excellent abrasion resistance	Recommended for low temperature environments	Recommended for low temperature environments	Excellent chemical compatibility in a wide range of industrial applications	Broad chemical resistance, steam resistant with excellent compression set at high temperatures	Recommended for low temperature environments
-30°C ~220°C	-15°C ~220°C	-15°C ~130°C	-40°C ~130°C	-30°C ~220°C	-5°C ~220°C	0°C ~280°C	-30°C ~230°C
-40°C ~250°C	-25°C ~250°C	-40°C ~150°C	-55°C ~150°C	-40°C ~250°C	-25°C ~250°C	-10°C ~300°C	-40°C ~250°C
Excellent	Excellent	Excellent	Excellent	Excellent	Excellent	Excellent	Excellent
Excellent	Excellent	Excellent	Excellent	Excellent	Excellent	Excellent	Excellent
Excellent	Excellent	Good	Good	Excellent	Excellent	Excellent	Excellent
Good	Good	Poor	Poor	Good	Good	Excellent	Excellent

## EN549 Material Features

Rubber materials for seals and diaphragms for gas appliances and gas equipment.

Compound Number	H7000AA	H7007AR	N5017AA	N6017AA	N6967AA
Polymer	HNBR	HNBR	NBR	NBR	NBR
Hardness (Shore A)	70	70	50	60	70
Temperature Range (°C)	C1/H3 (0 UP TO +100 °C)	C2/H3 (-20 UP TO +100 °C)	B2/H2 (-20 UP TO +80 °C)	B2/H2 (-20 UP TO +80 °C)	B3/H3 (-30 UP TO +80 °C)

## UL157 Material Features

The basic standard that covers the test methods used to investigate elastomeric gaskets and seals is ANSI/UL 157.

Compound Number	V7015AA	V7500AA	C7100AA	N5017AA	N7060AA	N8017AA	S7000AB	F7004BU02
Polymer	FKM	FKM	CR	NBR	NBR	NBR	Silicone	Fluorosilicone
Hardness (Shore A)	70	75	70	50	70	80	70	70
UL Listing Service Temp Range( °C)	-60 ~ 200	-40 ~ 200	-40 ~ 60	-40 ~ 60	-40 ~ 60	-40 ~ 60	-60~135	-55~80
Test Condition	UL157	●	●	●	●	●	●	●
	UL 778				●			
	UL 50E	●	●		●	●	●	●
	UL87A	E85			E85			E85
	UL 87B	B20			B100			B100
	UL 87C	Diesel						Diesel
	End Use	B, C(Ethanol), D, G	B, C(Ethanol), D, F, G, H, J	R(R-12, R-22, R-134a)	F, G, J	A(Water, Dry Chemical), B, C(Ethanol), D, F, G, J	F, G, J	L, M, N, O

## AFLAS®

AFLAS® (TFE/propylene polymer) is better base and steam resistant than other general Vitons. It can be use in amine, amide and some bases. (AFLAS® is a registered trademark of AGC Chemicals.)







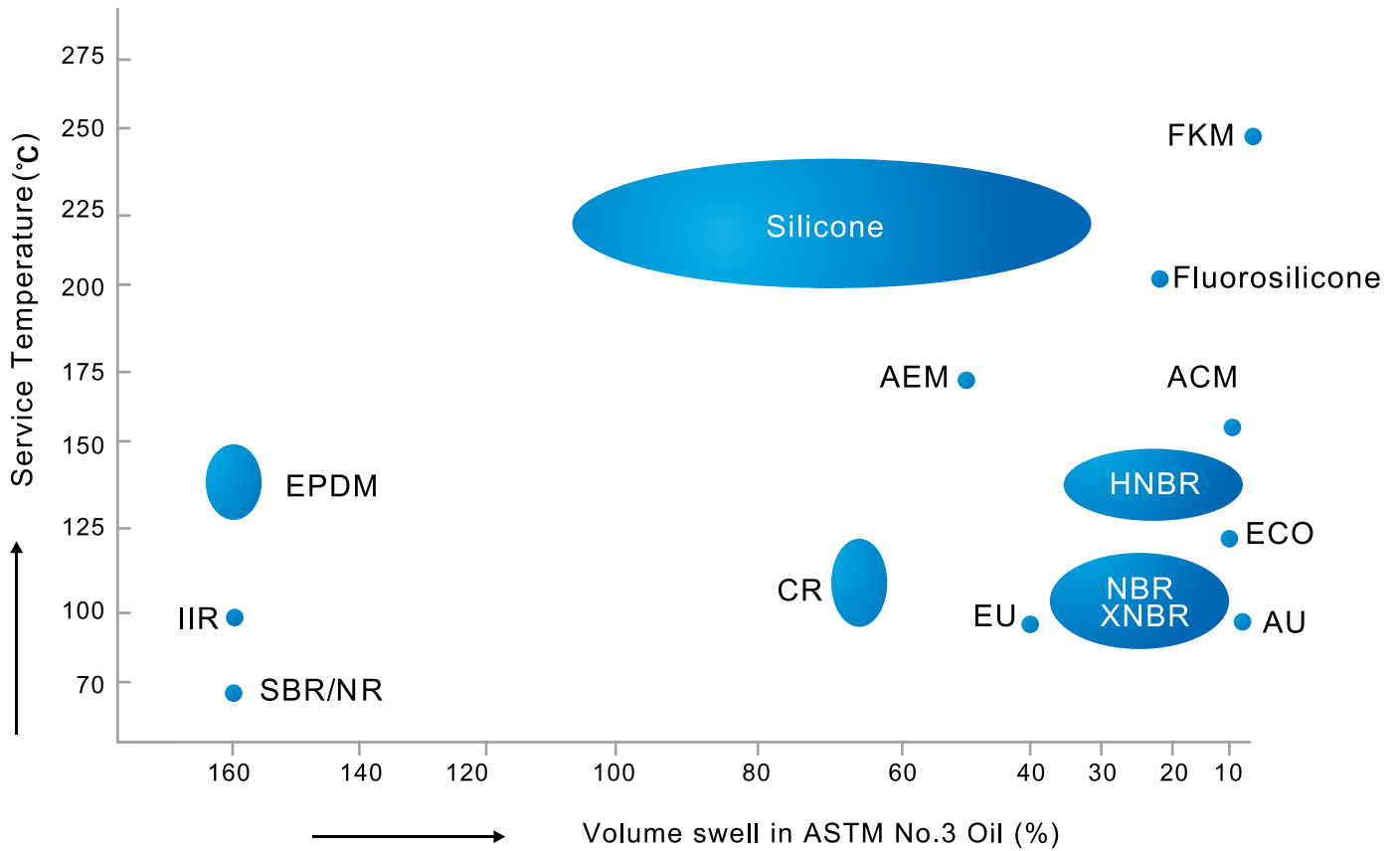







Compound Number	V7045AA	V7545AA	V8045AA	V9045AA
Polymer	AFLAS®	AFLAS®	AFLAS®	AFLAS®
Hardness (Shore A)	70	75	80	90
Service Temperature (°C)	-5~250	-5~250	-5~250	-5~250

N7000AA	N7017AA	N8614AA	N9026AA	V7500AC	V8000CT
NBR	NBR	NBR	NBR	FKM	FKM
70	70	90	90	75	80
B1/H3 (0 UP TO +80 °C)	B2/H3 (-20 UP TO +80 °C)	B1/H3 (0 UP TO +80 °C)	B2/H3 (-20 UP TO +80 °C)	E1/H3 (0 UP TO +150 °C)	E1/H3 (0 UP TO +150 °C)

## Oil And Heat Resistance Comparison Chart



# Basic Products and Materials for Oil & Gas Industry

			Well Drilling & Exploration	Well Test & Completion
Basic Product Types	O-Ring		●	●
	PF		●	
	PA		●	●
	TR		●	
	RB			
	Hammer Union		●	●
	T-Seal		●	●
	S-Seal		●	●
	Delta Ring		●	
	U-Cup			
	Guide Ring			
	WB			
	Back-up Ring		●	●
	VD		●	
	VP		●	●
	V-Packing		●	●
Elastomer * Certified to AED / RGD Standards	FKM*		●	●
	HNBR*		●	●
	FEPM		●	●
	FFKM*		●	●
Thermoplastic	PEEK		●	●
	PTFE		●	●
	TPU		●	



Wellheads : Packer & hangers	Blow-Out Preventers (BOPs)	Ball Valves and Pump & Compressor	Subsea Production
●	●	●	●
●		●	●
●	●	●	●
			●
		●	●
●	●	●	●
●	●	●	●
●	●	●	●
			●
●	●		●
			●
●	●	●	●
●			
●		●	●
●	●	●	●
●	●	●	●
●	●	●	●
●	●	●	●
●	●	●	●
●	●	●	●
●	●	●	●
●		●	●
		●	●

# Products

---



## O-Rings

GMORS manufactures O-Rings in numerous elastomeric compounds, including RGD resistant compounds, that are recommended for use in hostile environments found in oil and gas industry applications. GMORS produces precision O-Rings in all standard AS 568, Metric, SMS 1586, JIS B2401, BS 4518, GB/T3452.1, JASO F404 sizes as well as non-standard sizes.

## Hammer Union Seals

Hammer unions also referred to as wing unions are designed to be quick connect/disconnect couplings that are typically used in temporary flow lines or in equipment that will be periodically disassembled. The hammer union seal is a relatively large elastomeric annular seal that is rectangular in cross section. The seal is “actuated” when it is compressed between the coupling components when they are cinched up. The hammer union seal is exposed to the gases and fluids that flow through the coupling making the choice of the optimum rubber compound critical. GMORS manufactures hammer union seals, from sizes 2" up to 4", in a number of compounds including RGD resistant compounds.



## T-Seals

T-Seals are compact three piece double acting seals consisting of a T shaped elastomeric element and two rigid anti-extrusion rings. These compact sealing elements are designed to fit into simple O-Ring grooves and are frequently used to retrofit O-Rings that are failing. The T-Seal's geometry prevents spiraling and because it utilizes rigid back-up materials, it can withstand very high pressures and large extrusion gaps. T-Seals can be used in dynamic or static applications in many oilfield applications including intensifiers, jacks, cylinders, tensioners, shock subs, bumper subs, valves and pumps.

GMORS' T Seals can be either piston type or rod type.



## S-Seals

The S-Seal is a compact single piece construction elastomeric seal that incorporates two metal anti-extrusion rings that are molded into the seal's outer edges. S-Seals are bi-directional seals that fit into O-Ring type grooves but can perform at high pressures (up to 20,000 psi) and temperatures that cause O-Rings to fail. GMORS S-Seals are well suited for sealing wellheads, connectors, downhole tools, high pressure valves and other demanding oil and gas applications. The non-extrusion springs can be fabricated from different metals as well as PEEK.



## FS-Seals

FS-Seals are robust interference sealing elements that can seal against the large clearances and rough surfaces particularly found between a wellhead and a rough mill casing. These are large cross section, system pressure energized seals that are capable of bridging large extrusion gaps and sealing against equipment diameters that are not consistent.

FS-Seals are ID Seals that can seal up to 10,000 psi over a wide temperature range. To enhance the FS Seals' anti-extrusion capability, two toroidal springs are molded into the outer edges of the primary sealing face. FS-Seals are available in a number of elastomeric compounds including RGD resistant compounds that offer reliable solutions that provide excellent service in chemically aggressive and highly abrasive media.

## Packer Elements

Packer elements are flexible elastomeric components that are used to seal between the outside diameter of the production tubing and the casing, liner or wellbore. Sealing is typically accomplished by expanding the device once it has been run into its desired location within the well. GMORS produces a variety of homogeneous elastomeric downhole packer elements in both standard as well as custom designs. GMORS' RGD elastomeric compounds create packer elements that perform extremely well in the harsh and hostile operating conditions found in the well environment. Metallic and non-metallic back-up materials are incorporated into GMORS' packer elements when they are required.



## Symmetrical Rod / Piston U-Cup Seal

GMORS Symmetrical Rod/Piston U-Cup Seal is a TPU U-Cup seal with a NBR O-Ring loaded. We have two types UH1 (square design with a straight lip) and UH2 (deep design with a beveled lip).

▣ UH1– The O-Ring energized lips assure a uniform, positive lip contact plus excellent low pressure sealing. Seal depth is equal to radial width. UH1 is used to interchange an existing hydraulic packing and/or O-Rings.

▣ UH2 –The back beveled sealing lip provides greater film breaking and increased until loading at the sealing surface. Seal depth is generally 1.5 times the cross section of radial width to insure seal stability in most rugged applications. ROD SEAL use is preferred.

## Custom Rubber Molded Parts

GMORS offers simple to complex precision custom rubber molded parts from a vast array of available compounds including RGD resistant compounds. Parts can be compression molded, injection molded or transfer molded. Virtually any size or quantity requirement can be met. All molds and tooling are produced in house on modern precision equipment.



## BOP Seal

BOP Seals is using in a large, specialized valve or mechanical device to use to seal, control and monitor oil and gas wells to prevent blowouts and the safety of the rig.

GMORS produce wide range of BOP seals in both inner BOP seal and outer BOP seal. Custom designed are also available.

## HiPerSeal<sup>®</sup> with Helical Spring

HiPerSeal<sup>®</sup> with Helical spring is designed with high spring rate for medium and heavy load application. The spring produces evenly distributed load across each individual band. It can completely replace standard Inch fractional and AS568 O-Ring without any modification. Standard spring material is 17-7ph but NACE compliant Elgiloy and Hastelloy are also available. HiPerSeal<sup>®</sup> with helical spring is not suitable for wide gland tolerances, eccentricity or misalignment. HiPerSeal<sup>®</sup> with Helical spring is mostly adopted for static application.





## HiPerSeal® with V-Spring

HiPerSeal® with V-shaped spring is designed with a V-spring owning long beam leg providing a continued spring load at the leading edge of PTFE seal jacket. HiPerSeal® with V-spring can completely replace standard Inch fractional and AS568 O-Ring without any modification. Standard spring material is 301SS and 316SS but other special corrosion resistant materials such as Elgiloy and Hastelloy are also available. Optional scraper lip is designed for applications where abrasive media exists. HiPerSeal® with V-spring can be adopted for reciprocating and rotary applications.

## HiPerSeal® with C-Spring

HiPerSeal® with C-spring is designed with a canted coil spring which is produced from a metal coil. The canted coil spring provides a very flat load curve under compression and provides constant loads via its deflection range. Standard spring material is 300 series stainless steels but other special corrosion resistant alloy is also available. There are light, medium and high load series for all series of canted coil springs. HiPerSeal® with C-spring can be adopted for both static and dynamic applications. HiPerSeal® with C-spring is the most popular design in Electronic and semi-conductor applications.

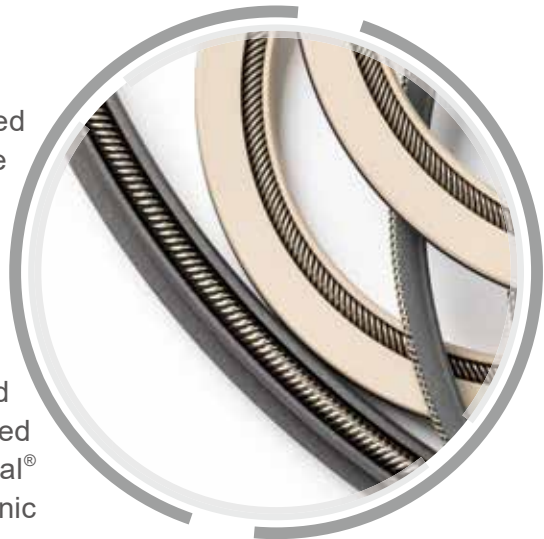

# Piston T-Seals

Seal Materials
NBR
FKM
HNBR
EPDM
Back-up Ring Materials
PTFE
Nylon
PEEK

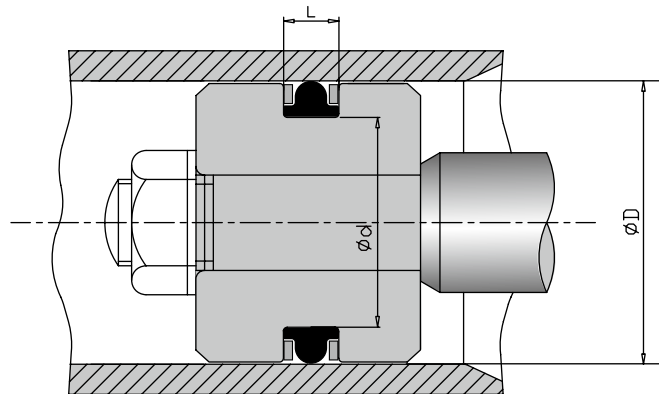

Code	Dimensions			Gland Dimensions(mm)			Gland Dimensions(inch)			
	T-SEAL (AS-568) Dash Number	Nominal (Inch)		Bore Dia. (Cylinder) D	Groove Dia. (Piston) d	No BACK-UP Width L + 0.13 - 0.00	Bore Dia. (Cylinder) D	Groove Dia. (Piston) d	No BACK-UP Width L + 0.005 - 0.000	
		ID	OD							CS
T001-201	201	3/16	7/16	1/8	11.10	4.95	4.75	0.437	0.195	0.187
T001-202	202	1/4	1/2		12.70	6.55		0.500	0.258	
T001-203	203	5/16	9/16		14.27	8.13		0.562	0.320	
T001-204	204	3/8	5/8		15.88	9.73		0.625	0.383	
T001-205	205	7/16	11/16		17.45	11.30		0.687	0.445	
T001-206	206	1/2	3/4		19.05	12.90		0.750	0.508	
T001-207	207	9/16	13/16		20.62	14.48		0.812	0.570	
T001-208	208	5/8	7/8		22.23	16.08		0.875	0.633	
T001-209	209	11/16	15/16		23.80	17.65		0.937	0.695	
T001-210	210	3/4	1		25.40	19.25		1.000	0.758	
T001-211	211	13/16	1 1/16		26.97	20.83		1.062	0.820	
T001-212	212	7/8	1 1/8		28.58	22.43		1.125	0.883	
T001-213	213	15/16	1 3/16		30.15	24.00		1.187	0.945	
T001-214	214	1	1 1/4		31.75	25.60		1.250	1.008	
T001-215	215	1 1/16	1 5/16		33.32	27.18		1.312	1.070	
T001-216	216	1 1/8	1 3/8		34.93	28.78		1.375	1.133	
T001-217	217	1 3/16	1 7/16		36.50	30.35		1.437	1.195	
T001-218	218	1 1/4	1 1/2		38.10	31.95		1.500	1.258	
T001-219	219	1 5/16	1 9/16		39.67	33.53		1.562	1.320	
T001-220	220	1 3/8	1 5/8		41.28	35.13		1.625	1.383	
T001-221	221	1 7/16	1 11/16	42.85	36.70	1.687	1.445			
T001-222	222	1 1/2	1 3/4	44.45	38.30	1.750	1.508			
T001-309	309	7/16	13/16	3/16	20.62	11.23	7.14	0.812	0.442	0.281
T001-310	310	1/2	7/8		22.23	12.83		0.875	0.505	
T001-311	311	9/16	15/16		23.80	14.40		0.937	0.567	
T001-312	312	5/8	1		25.40	16.00		1.000	0.630	
T001-313	313	11/16	1 1/16		26.97	17.58		1.062	0.692	
T001-314	314	3/4	1 1/8		28.55	19.18		1.124	0.755	
T001-315	315	13/16	1 3/16		30.15	20.75		1.187	0.817	
T001-316	316	7/8	1 1/4		31.75	22.35		1.250	0.880	
T001-317	317	15/16	1 5/16		33.32	23.93		1.312	0.942	
T001-318	318	1	1 3/8		34.93	25.53		1.375	1.005	
T001-319	319	1 1/16	1 7/16		36.50	27.10		1.437	1.067	

Code	Dimensions				Gland Dimensions(mm)			Gland Dimensions(inch)		
	T-SEAL (AS-568) Dash Number	Nominal (Inch)			Bore Dia. (Cylinder) D	Groove Dia. (Piston) d	No BACK-UP Width L + 0.13 - 0.00	Bore Dia. (Cylinder) D	Groove Dia. (Piston) d	No BACK-UP Width L + 0.005 - 0.000
		ID	OD	CS						
T001-320	320	1 1/8	1 1/2	3/16	38.10	28.70	7.14	1.500	1.130	0.281
T001-321	321	1 3/16	1 9/16		39.67	30.28		1.562	1.192	
T001-322	322	1 1/4	1 5/8		41.28	31.88		1.625	1.255	
T001-323	323	1 5/16	1 11/16		42.85	33.45		1.687	1.317	
T001-324	324	1 3/8	1 3/4		44.45	35.05		1.750	1.380	
T001-325	325	1 1/2	1 7/8		47.63	38.23		1.875	1.505	
T001-326	326	1 5/8	2		50.80	41.40		2.000	1.630	
T001-327	327	1 3/4	2 1/8		53.98	44.58		2.125	1.755	
T001-328	328	1 7/8	2 1/4		57.15	47.75		2.250	1.880	
T001-329	329	2	2 3/8		60.33	50.93		2.375	2.005	
T001-330	330	2 1/8	2 1/2		63.50	54.10		2.500	2.130	
T001-331	331	2 1/4	2 5/8		66.68	57.28		2.625	2.255	
T001-332	332	2 3/8	2 3/4		69.85	60.45		2.750	2.380	
T001-333	333	2 1/2	2 7/8		73.03	63.63		2.875	2.505	
T001-334	334	2 5/8	3		76.20	66.80		3.000	2.630	
T001-335	335	2 3/4	3 1/8		79.38	69.98		3.125	2.755	
T001-336	336	2 7/8	3 1/4		82.55	73.15		3.250	2.880	
T001-337	337	3	3 3/8		85.73	76.33		3.375	3.005	
T001-338	338	3 1/8	3 1/2		88.90	79.50		3.500	3.130	
T001-339	339	3 1/4	3 5/8		92.08	82.68		3.625	3.255	
T001-340	340	3 3/8	3 3/4		95.25	85.85		3.750	3.380	
T001-341	341	3 1/2	3 7/8		98.43	89.03		3.875	3.505	
T001-342	342	3 5/8	4		101.60	92.20		4.000	3.630	
T001-343	343	3 3/4	4 1/8		104.78	95.38		4.125	3.755	
T001-344	344	3 7/8	4 1/4		107.95	98.55		4.250	3.880	
T001-345	345	4	4 3/8		111.13	101.73		4.375	4.005	
T001-346	346	4 1/8	4 1/2		114.30	104.90		4.500	4.130	
T001-347	347	4 1/4	4 5/8		117.48	108.08		4.625	4.255	
T001-348	348	4 3/8	4 3/4		120.65	111.25		4.750	4.380	
T001-349	349	4 1/2	4 7/8		123.83	114.43		4.875	4.505	
T001-425	425	4 1/2	5		1/4	127.05		115.01	9.53	
T001-426	426	4 5/8	5 1/8	130.23		118.19	5.127	4.653		
T001-427	427	4 3/4	5 1/4	133.40		121.36	5.252	4.778		
T001-428	428	4 7/8	5 3/8	136.58		124.54	5.377	4.903		
T001-429	429	5	5 1/2	139.75		127.71	5.502	5.028		
T001-430	430	5 1/8	5 5/8	142.93		130.89	5.627	5.153		
T001-431	431	5 1/4	5 3/4	146.10		134.06	5.752	5.278		
T001-432	432	5 3/8	5 7/8	149.28		137.24	5.877	5.403		
T001-433	433	5 1/2	6	152.45		140.41	6.002	5.528		
T001-434	434	5 5/8	6 1/8	155.63		143.59	6.127	5.653		
T001-435	435	5 3/4	6 1/4	158.80		146.76	6.252	5.778		
T001-436	436	5 7/8	6 3/8	161.98		149.94	6.377	5.903		
T001-437	437	6	6 1/2	165.15		153.11	6.502	6.028		
T001-438	438	6 1/4	6 3/4	171.50		159.46	6.752	6.278		
T001-439	439	6 1/2	7	177.85		165.81	7.002	6.528		
T001-440	440	6 3/4	7 1/4	184.20		172.16	7.252	6.778		



Code	Dimensions			Gland Dimensions(mm)			Gland Dimensions(inch)			
	T-SEAL (AS-568) Dash Number	Nominal (Inch)		Bore Dia. (Cylinder)	Groove Dia. (Piston)	No BACK-UP Width	Bore Dia. (Cylinder)	Groove Dia. (Piston)	No BACK-UP Width	
		ID	OD							CS
T001-441	441	7	7 1/2	1/4	190.55	178.51	9.53	7.502	7.028	0.375
T001-442	442	7 1/4	7 3/4		196.90	184.86		7.752	7.278	
T001-443	443	7 1/2	8		203.25	191.21		8.002	7.528	
T001-444	444	7 3/4	8 1/4		209.60	197.56		8.252	7.778	
T001-445	445	8	8 1/2		215.95	203.91		8.502	8.028	
T001-446	446	8 1/2	9		228.65	216.61		9.002	8.528	
T001-447	447	9	9		241.35	229.31		9.502	9.028	
T001-448	448	9 1/2	10		254.05	242.01		10.002	9.528	
T001-449	449	10	10 1/2		266.75	254.71		10.502	10.028	
T001-450	450	10 1/2	11		279.45	267.41		11.002	10.528	
T001-451	451	11	11 1/2		292.15	280.11		11.502	11.028	
T001-452	452	11 1/2	12		304.85	292.81		12.002	11.528	
T001-453	453	12	12 1/2		317.55	305.51		12.502	12.028	
T001-454	454	12 1/2	13		330.25	318.21		13.002	12.528	
T001-455	455	13	13 1/2		342.95	330.91		13.502	13.028	
T001-456	456	13 1/2	14		355.65	343.61		14.002	13.528	
T001-457	457	14	14 1/2		368.35	356.31		14.502	14.028	
T001-458	458	14 1/2	15		381.05	369.01		15.002	14.528	
T001-459	459	15	15 1/2		393.75	381.71		15.502	15.028	
T001-460	460	15 1/2	16		406.45	394.41		16.002	15.528	
T001-462	462	16 1/2	17	431.85	419.81	17.002	16.528			

# Rod T-Seals

Seal Materials
NBR
FKM
HNBR
EPDM
Back-up Ring Materials
PTFE
Nylon
PEEK

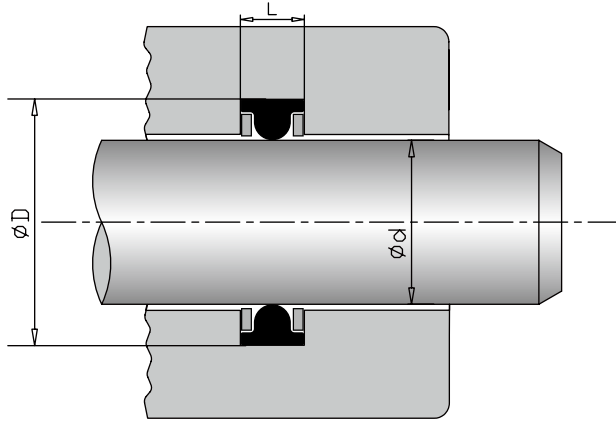

Code	Dimensions				Gland Dimensions (mm)			Gland Dimensions (Inch)		
	T-SEAL (AS-568) Dash Number	Nominal (Inch)		CS	Groove Dia. (Rod Gland) D	Rod Diameter d	No BACK-UP Width L + 0.13 - 0.00	Groove Dia. (Rod Gland) D	Rod Diameter d	No BACK-UP Width L + 0.005 - 0.000
		ID	OD							
T002-201	201	3/16	7/16	1/8	10.85	4.70	4.75	0.427	0.185	0.187
T002-202	202	1/4	1/2		12.45	6.30		0.490	0.248	
T002-203	203	5/16	9/16		14.02	7.87		0.552	0.310	
T002-204	204	3/8	5/8		15.62	9.47		0.615	0.373	
T002-205	205	7/16	11/16		17.20	11.05		0.677	0.435	
T002-206	206	1/2	3/4		18.80	12.65		0.740	0.498	
T002-207	207	9/16	13/16		20.37	14.22		0.802	0.560	
T002-208	208	5/8	7/8		21.97	15.82		0.865	0.623	
T002-209	209	11/16	15/16		23.55	17.40		0.927	0.685	
T002-210	210	3/4	1		25.15	19.00		0.990	0.748	
T002-211	211	13/16	1 1/16		26.72	20.57		1.052	0.810	
T002-212	212	7/8	1 1/8		28.32	22.17		1.115	0.873	
T002-213	213	15/16	1 3/16		29.90	23.75		1.177	0.935	
T002-214	214	1	1 1/4		31.50	25.35		1.240	0.998	
T002-215	215	1 1/16	1 5/16		33.07	26.92		1.302	1.060	
T002-216	216	1 1/8	1 3/8		34.67	28.52		1.365	1.123	
T002-217	217	1 3/16	1 7/16		36.25	30.10		1.427	1.185	
T002-218	218	1 1/4	1 1/2		37.85	31.70		1.490	1.248	
T002-219	219	1 5/16	1 9/16		39.42	33.27		1.552	1.310	
T002-220	220	1 3/8	1 5/8		41.02	34.87		1.615	1.373	
T002-221	221	1 7/16	1 11/16	42.60	36.45	1.677	1.435			
T002-222	222	1 1/2	1 3/4	44.20	38.05	1.740	1.498			
T002-309	309	7/16	13/16	3/16	20.45	11.05	7.14	0.805	0.435	0.281
T002-310	310	1/2	7/8		22.05	12.65		0.868	0.498	
T002-311	311	9/16	15/16		23.62	14.22		0.930	0.560	
T002-312	312	5/8	1		25.22	15.82		0.993	0.623	
T002-313	313	11/16	1 1/16		26.80	17.40		1.055	0.685	
T002-314	314	3/4	1 1/8		28.40	19.00		1.118	0.748	
T002-315	315	13/16	1 3/16		29.97	20.57		1.180	0.810	
T002-316	316	7/8	1 1/4		31.57	22.17		1.243	0.873	
T002-317	317	15/16	1 5/16		33.15	23.75		1.305	0.935	
T002-318	318	1	1 3/8		34.75	25.35		1.368	0.998	

Code	Dimensions				Gland Dimensions (mm)			Gland Dimensions (Inch)					
	T-SEAL (AS-568) Dash Number	Nominal (Inch)			Groove Dia. (Rod Gland)  D	Rod Diameter  d	No BACK-UP Width  L + 0.13 - 0.00	Groove Dia. (Rod Gland)  D	Rod Diameter  d	No BACK-UP Width  L + 0.005 - 0.000			
		ID	OD	CS									
T002-319	319	1 1/16	1 7/16	3/16	36.32	26.92	7.14	1.430	1.060	0.281			
T002-320	320	1 1/8	1 1/2		37.92	28.52		1.493	1.123				
T002-321	321	1 3/16	1 9/16		39.50	30.10		1.555	1.185				
T002-322	322	1 1/4	1 5/8		41.10	31.70		1.618	1.248				
T002-323	323	1 5/16	1 11/16		42.67	33.27		1.680	1.310				
T002-324	324	1 3/8	1 3/4		44.27	34.87		1.743	1.373				
T002-325	325	1 1/2	1 7/8		47.45	38.05		1.868	1.498				
T002-326	326	1 5/8	2		50.62	41.22		1.993	1.623				
T002-327	327	1 3/4	2 1/8		53.80	44.40		2.118	1.748				
T002-328	328	1 7/8	2 1/4		56.97	47.57		2.243	1.873				
T002-329	329	2	2 3/8		60.15	50.75		2.368	1.998				
T002-330	330	2 1/8	2 1/2		63.32	53.92		2.493	2.123				
T002-331	331	2 1/4	2 5/8		66.50	57.10		2.618	2.248				
T002-332	332	2 3/8	2 3/4		69.67	60.27		2.743	2.373				
T002-333	333	2 1/2	2 7/8		72.85	63.45		2.868	2.498				
T002-334	334	2 5/8	3		76.02	66.62		2.993	2.623				
T002-335	335	2 3/4	3 1/8		79.20	69.80		3.118	2.748				
T002-336	336	2 7/8	3 1/4		82.37	72.97		3.243	2.873				
T002-337	337	3	3 3/8		85.55	76.15		3.368	2.998				
T002-338	338	3 1/8	3 1/2		88.72	79.32		3.493	3.123				
T002-339	339	3 1/4	3 5/8		91.90	82.50		3.618	3.248				
T002-340	340	3 3/8	3 3/4		95.07	85.67		3.743	3.373				
T002-341	341	3 1/2	3 7/8		98.25	88.85		3.868	3.498				
T002-342	342	3 5/8	4		101.42	92.02		3.993	3.623				
T002-343	343	3 3/4	4 1/8		104.60	95.20		4.118	3.748				
T002-344	344	3 7/8	4 1/4		107.77	98.37		4.243	3.873				
T002-345	345	4	4 3/8		110.95	101.55		4.368	3.998				
T002-346	346	4 1/8	4 1/2		114.12	104.72		4.493	4.123				
T002-347	347	4 1/4	4 5/8		117.30	107.90		4.618	4.248				
T002-348	348	4 3/8	4 3/4		120.47	111.07		4.743	4.373				
T002-349	349	4 1/2	4 7/8		123.65	114.25		4.868	4.498				
T002-425	425	4 1/2	5		1/4	126.26		114.22	9.53		4.971	4.497	0.375
T002-426	426	4 5/8	5 1/8			129.44		117.40			5.096	4.622	
T002-427	427	4 3/4	5 1/4			132.61		120.57			5.221	4.747	
T002-428	428	4 7/8	5 3/8	135.79		123.75	5.346	4.872					
T002-429	429	5	5 1/2	138.96		126.92	5.471	4.997					
T002-430	430	5 1/8	5 5/8	142.14		130.10	5.596	5.122					
T002-431	431	5 1/4	5 3/4	145.31		133.27	5.721	5.247					
T002-432	432	5 3/8	5 7/8	148.49		136.45	5.846	5.372					
T002-433	433	5 1/2	6	151.66		139.62	5.971	5.497					
T002-434	434	5 5/8	6 1/8	154.84		142.80	6.096	5.622					
T002-435	435	5 3/4	6 1/4	158.01		145.97	6.221	5.747					
T002-436	436	5 7/8	6 3/8	161.19		149.15	6.346	5.872					
T002-437	437	6	6 1/2	164.36		152.32	6.471	5.997					
T002-438	438	6 1/4	6 3/4	170.71		158.67	6.721	6.247					
T002-439	439	6 1/2	7	177.06		165.02	6.971	6.497					

Code	Dimensions				Gland Dimensions (mm)			Gland Dimensions (Inch)		
	T-SEAL (AS-568) Dash Number	Nominal (Inch)		CS	Groove Dia. (Rod Gland)	Rod Diameter	No BACK-UP Width	Groove Dia. (Rod Gland)	Rod Diameter	No BACK-UP Width
		ID	OD		D	d	L + 0.13 - 0.00	D	d	L + 0.005 - 0.000
T002-440	440	6 3/4	7 1/4	1/4	183.41	171.37	9.53	7.221	6.747	0.375
T002-441	441	7	7 1/2		189.76	177.72		7.471	6.997	
T002-442	442	7 1/4	7 3/4		196.11	184.07		7.721	7.247	
T002-443	443	7 1/2	8		202.46	190.42		7.971	7.497	
T002-444	444	7 3/4	8 1/4		208.81	196.77		8.221	7.747	
T002-445	445	8	8 1/2		215.16	203.12		8.471	7.997	
T002-446	446	8 1/2	9		227.86	215.82		8.971	8.497	
T002-447	447	9	9		240.56	228.52		9.471	8.997	
T002-448	448	9 1/2	10		253.26	241.22		9.971	9.497	
T002-449	449	10	10 1/2		265.96	253.92		10.471	9.997	
T002-450	450	10 1/2	11		278.66	266.62		10.971	10.497	
T002-451	451	11	11 1/2		291.36	279.32		11.471	10.997	
T002-452	452	11 1/2	12		304.06	292.02		11.971	11.497	
T002-453	453	12	12 1/2		316.76	304.72		12.471	11.997	
T002-454	454	12 1/2	13		329.46	317.42		12.971	12.497	
T002-455	455	13	13 1/2		342.16	330.12		13.471	12.997	
T002-456	456	13 1/2	14		354.86	342.82		13.971	13.497	
T002-457	457	14	14 1/2		367.56	355.52		14.471	13.997	
T002-458	458	14 1/2	15		380.26	368.22		14.971	14.497	
T002-459	459	15	15 1/2		392.96	380.92		15.471	14.997	
T002-460	460	15 1/2	16		405.66	393.62		15.971	15.497	
T002-462	462	16 1/2	17		431.06	419.02		16.971	16.497	







# GMORS OFFER EDI SERVICES

## Electronic Data Interchange

In November 2019, GMORS established a B2B Electronic Data Interchange (EDI) platform in support of customer electronic data exchange. This will save transaction processing time for both parties and enable exchange process verification and data security.

We welcome customers who are interested in our EDI services to contact our customer support representatives.

## O-Ring Master

GMORS O-Ring Master provides international standard size lookup for rubber sealing rings. With this APP, you can operate it without an internet connection. In addition to O-rings, you can also find the size of X-rings and reinforcement rings (back-up rings). You can also search for the appropriate O-ring based on the groove size of the installed cylinder.

## Material Master

GMORS Material Master provides material recommendations based on the application environment of your rubber seal products, such as "temperature" and "media". We provide nearly a thousand types of media to compare the compatibility of materials.



Android



iOS

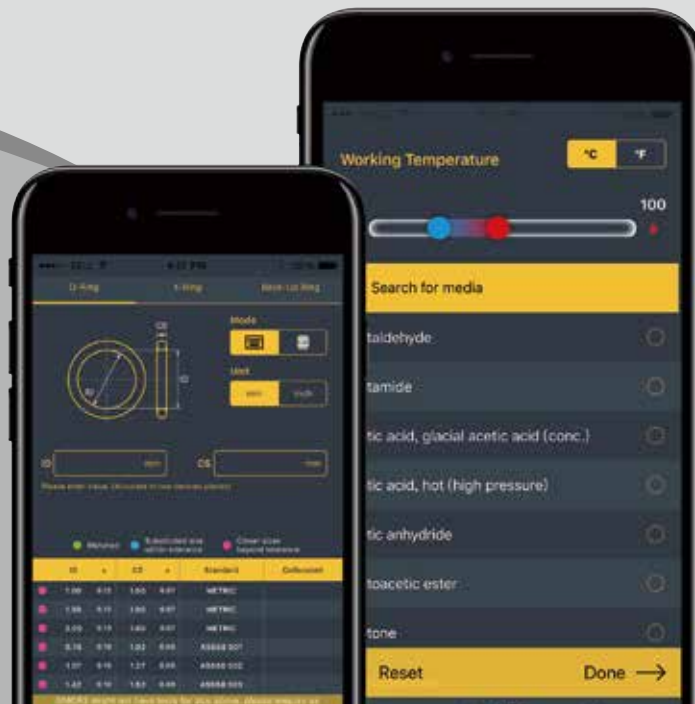

Android



iOS



# GMORS®

*Seals to your heart*

## GMORS Taiwan (Headquarters)

No. 15, Kung Yeh East 4th Rd.,  
Lukang, Chang Hua 505, Taiwan.  
T : +886-47810288(REP.)  
E : Inquiry@gmors.com

## GMORS Thailand

700/889 Moo.3 Amata City Chonburi  
Industrial Estate T. Nong Kakha A.  
Pantong Chonburi 20160 Thailand  
T : +66-38185399  
E : Inquiry@gmors.co.th

## GMORS Korea

1018, Galmachi-ro 314, Jungwon-gu,  
Seongnam-si, Gyeonggi-do,  
Republic of Korea  
T : +82-316396606  
E : Inquiry@gmors.co.kr

## GMORS Japan

1 Chome-11-14 Honjo, Sumida City,  
Tokyo 130-0004 Japan  
T : +81-368032026  
E : Inquiry@gmors.co.jp

## GMORS India

Unit No. 12-14 Indialand-Global  
Industrial Park, Hinjawadi Phase1,  
Pune - 411057, India.  
T : +91-2067994400  
E : Inquiry@gmors.co.in

## GMORS Vietnam

GD4-1 in Ngoc Hoi Industrial Park,  
Thanh Tri district - Hanoi city.  
T : +84-02439339018  
E : Inquiry@gmors.com.vn

## GMORS Colombia

Avenida 68 #17-28, Bogota DC,  
Colombia  
T : + 57-310 535 5092  
E : Inquiry@gmors.com.co

## GMORS Philippines

T : +63-9175501823  
E : Inquiry@gmors.com.ph

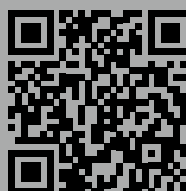

Catalog Download